

User manual

magnetic absolute
positioning drive

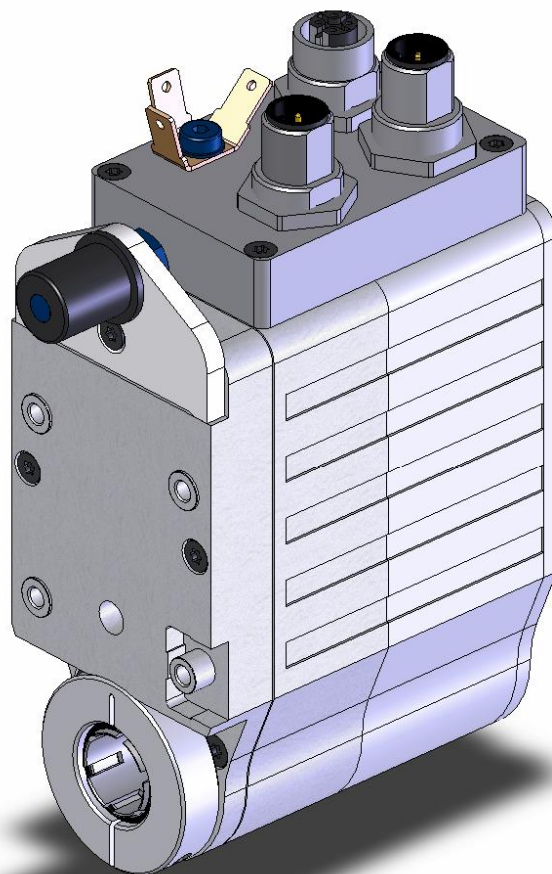

AG03





1	GENERAL REMARKS	3
1.1	SYMBOLS AND THEIR MEANING	3
1.2	DOCUMENTATION	3
2	FUNCTIONAL DESCRIPTION	4
2.1	SYSTEM STATUS WORD	4
2.2	OPERATING MODES	5
2.2.1	<i>Positioning mode</i>	5
2.2.1.1	Loop positioning	6
2.2.1.2	Inching operation	7
2.2.2	<i>Velocity mode</i>	9
2.3	TORQUE DEACTIVATION	9
2.4	RESTORE FACTORY SETTINGS VIA DIP SWITCHES	10
2.5	ENABLE INPUT	10
2.6	DRIVE BEHAVIOR IN CASE OF POWER FAILURE	11
3	CALIBRATION	11
4	EXTERNAL GEAR UNIT	11
5	WARNINGS / FAULTS	12
5.1	WARNINGS	12
5.2	FAULTS	12
5.2.1	<i>Error codes</i>	12
6	PARAMETER DESCRIPTION	13
7	COMMUNICATION VIA PROFIBUS – DP	16
7.1	GENERAL REMARKS	16
7.2	INTERFACE	16
7.3	DATA EXCHANGE	17
7.4	TELEGRAM SETUP (DATA EXCHANGE)	17
7.4.1	<i>Parameter Process Data Object</i>	17
7.4.2	<i>Parameter identification value (PKW)</i>	18
7.4.2.1	Parameter identification (PKE)	18
7.4.2.2	Sub-index (IND)	19
7.4.2.3	Parameter value (PWE)	19
7.4.3	<i>Process data (PZD)</i>	20
7.5	FUNCTIONAL DESCRIPTION OF THE CONTROL UNITS	21
7.5.1	<i>Control word in positioning mode (master ⇒ slave)</i>	22
7.5.2	<i>Status word: Positioning mode (slave ⇒ master)</i>	23
7.5.3	<i>Flow chart: Operating mode: Positioning mode</i>	24
7.5.4	<i>Control word: Velocity mode (master ⇒ slave)</i>	25
7.5.5	<i>Status word: Velocity mode (slave ⇒ master)</i>	26
7.5.6	<i>Flow chart: Operating mode: Velocity mode</i>	27
7.6	PARAMETERIZATION VIA PROFIBUS	28
7.6.1	<i>Example: read parameter</i>	30
7.6.2	<i>Example: Write parameter</i>	31
7.7	DIAGNOSIS	32
7.8	PROFIBUS ADDRESS SETUP	33
7.9	DIAGNOSIS LEDs	34
7.10	PROFIBUS BUS TERMINATOR	34
7.11	DEVICE DATA BASE AND CONFIGURATION	34

1 General remarks

This user manual is valid with firmware version 3.00 or higher!

1.1 Symbols and their meaning



This symbol precedes passages in the text that should be read with particular care to ensure flawless use of the AG03.



This symbol precedes passages in the text that contain additional important information.

1.2 Documentation

This user manual is valid for the AG03 absolute positioning drive and is intended to provide you with the necessary information on programming and activation of the AG03 positioning drive.



Please refer to the User Information for information on mechanical mounting, electrical connection, general safety instructions, correct usage as well as commissioning of the positioning drive.

2 Functional description

This chapter describes the operating cycles, functions and states required for the operation of the positioning drive.

Communication via Profibus DP is taken as the basis for the information presented in this chapter.

2.1 System status word

The system status word of the AG03 consists of 2 bytes and reflects the state of the AG03. The System status word can be read out as a hexadecimal value via Profibus Parameter 1020_{dez} (see chapter 7.6.: Parameterization via Profibus).

High- Byte								Low- Byte							
Bit – number															
15	14	13	12	11	10	9	8	7	6	5	4	3	2	1	0
0	0	1	0	1	0	0	1	0	1	0	0	1	0	0	0
2				9				4				8			

Fig. 1: System status word format

Example (grey background):

binary: ⇒ 0010 1001 0100 1000

hex: ⇒ 2 9 4 8

The table below informs about the meaning of the individual bits of the status word:

Bit	State	Description
Bit 0	'0'	no meaning
Bit 1	'0'	no meaning
Bit 2	'0'	no meaning
Bit 3	'1'	Positioning mode: In position Actual position is within the positioning window of the programmed target value.
	'0'	Actual position is beyond the positioning window of the programmed target value.
	'1'	Velocity mode: In position Actual velocity is within the specified tolerance window of the target speed
	'0'	Actual speed is outside the specified tolerance window.
Bit 4	'1'	Drive travels: Drive travels
	'0'	Drive stands still (velocity < 2 rev./min)
Bit 5	'1'	Positioning mode: upper limit: Actual position is above the higher programmed limit of limits 1+2. Travelling is possible only in negative direction in inching operation.
	'0'	Actual position is below the programmed limit.
	'0'	Velocity mode: no meaning
Bit 6	'1'	Positioning mode: lower limit: Actual position is below the lower programmed limit of limits 1+2. Travelling is possible only in positive direction in inching operation.
	'0'	Actual position is above the programmed limit.
	'0'	Velocity mode: no meaning

Bit	State	Description
Bit 7	'1'	Driver state: Motor is enabled
	'0'	Motor in control
Bit 8	'1'	Fault: The AG03 has switched to fault. The cause of the fault must be cleared and acknowledged via 'STW.7=1' command. For the fault cause see chapter 5.2
	'0'	No fault present
Bit 9	'1'	Positioning mode: loop travel: If travel direction unequal start direction (with loop travel)
	'0'	If travel direction equal start direction
	'0'	Velocity mode: no meaning
Bit 10	'1'	Status of the enable input Enable input deactivated Gear travel is disabled!
	'0'	Enable input activated
Bit 11	'1'	Ready-to-travel: Not ready-to-travel
	'0'	Ready-to-travel: <ul style="list-style-type: none"> • AG03 not in fault state • No active positioning • Enable input activated • actual position within limits (only positioning mode)
Bit 12	'1'	Battery voltage: Battery voltage too low for absolute encoder. Have the battery replaced at SIKO's within half a year after notice of error bit!
	'0'	Battery voltage OK.
Bit 13	'1'	Motor current: Motor current beyond permissible range. If this state lasts for more than 4 sec., the AG03 switches to fault.
	'0'	Motor current within permissible range.
Bit 14	'1'	Positioning mode: status Positioning active in positioning mode.
	'0'	Positioning inactive.
	'0'	Velocity mode: no meaning
Bit 15	'1'	Lag error: Lag error ⇒ AG03 cannot reach the preset speed due to too high load. This state should be avoided! Remedy: reduce programmed speed!
	'0'	No lag error ⇒ actual speed corresponds with required speed.

Table 1: System status word

2.2 Operating modes

The following operating modes are available: positioning mode and velocity mode. In the positioning mode there is the additional option of travelling with inching operation.

2.2.1 Positioning mode

Parameter no 20 'Operating mode' is programmed to positioning mode (see chapter 6: Parameter description).

In the positioning mode, positioning to the target value is effected by means of a ramp function (see fig. 2), which is calculated on the basis of the actual position as well as the programmed controller parameters P (proportional factor), I (integral factor), D (differential factor), acceleration and speed (see chapter 6: Parameter description).

After activation of the travel order (see *chapter 7.5.3 Flowchart: Positioning mode*) the AG03 accelerates with the pre-programmed acceleration to the specified speed. The measure of deceleration to reach the target value is also defined by the parameter 'a-pos'.

If the actual position is within the programmed window (see *chapter 6: parameter no. 10*), this will be signalled in the system status word (bit 3). The drive's behaviour upon reaching the pre-programmed window can be defined (see *chapter 6: parameter no. 26*).

Changing controller parameters during a positioning process does not influence the current positioning operation.

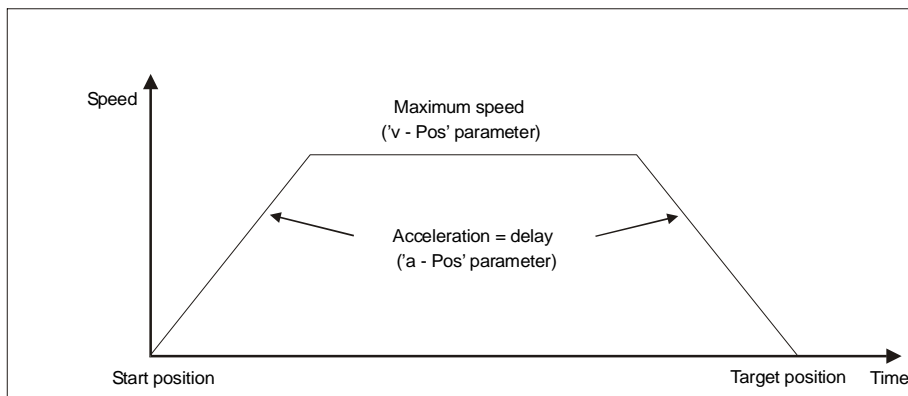

Fig. 2: Ramp travel in positioning mode (direct)

Travel orders can only be started if the following conditions have been met:

- the AG03 must not be switched to fault (*system status word bit 8 = '0'*)
- actual position is within the programmed limiting values. (*system status word bits 5 + 6 = '0'*)
- no active travel job present (*system status word bit 14 = 0*)
- Enable input activated (*system status word bit 10 = '0'*)

ZSW.15 = '1' is signalled when these conditions have been met.

2.2.1.1 Loop positioning

If the AG03 is operated on a spindle or an additional drive, the spindle or external drive play can be compensated by means of loop positioning.

In this case, travelling to the target value is always from the same direction.

This travel direction can be defined via the parameter no. 19 'Pos- Art' (see *chapter 6: Parameter description*).

Example:

Assumption: The direction of travelling for reaching any target position is positive (see *chapter 6: Parameter no. 19 'Pos Art' = loop*)

- Case 1 \Rightarrow new position is greater than actual position:
Direct travel to target position.
- Case 2 \Rightarrow new position is smaller than actual position:

The AG03 travels beyond the target position by the loop length (parameter no. 27) (bit 9 in the system status word signals travel direction unequal start direction); afterwards, travelling to the target value is in positive direction.

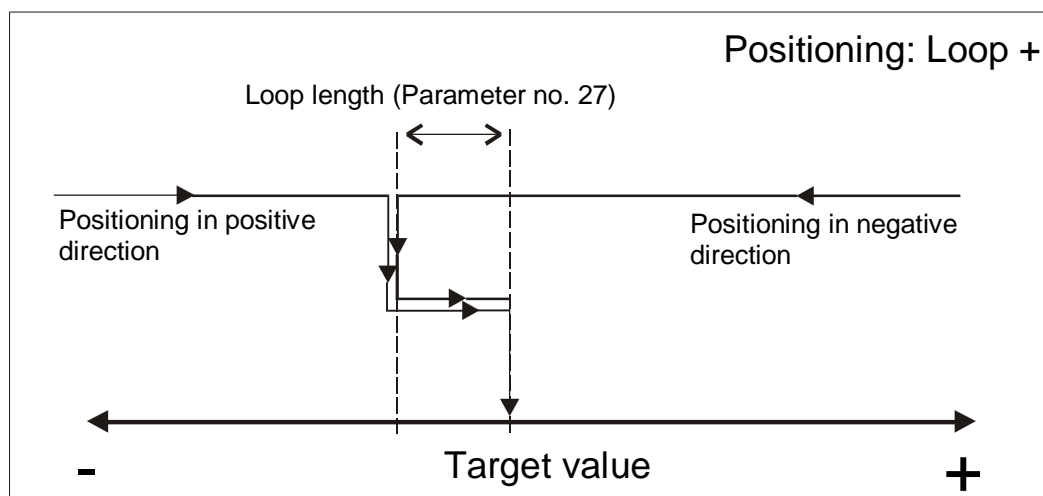

Fig. 3: Loop+ positioning

2.2.1.2 Inching operation

Inching operation is enabled in the 'Positioning mode' only. Acceleration and speed in the inching operation can be programmed via parameter no. 8 'a- Inch' and parameter no. 9 'v- Inch'.



There is no compensation for spindle play (loop positioning) in this travel type!

There are three options for travelling with inching operation:

- **Inching operation 1**

Inching operation 1 is started via STW.8 = '1' in the control word.

The drive travels once from the current position by the position 'Delta Inch'.

The travel direction is positive or negative depending on the arithmetical sign (*parameter no. 17 'Delta- Inch'*).

- Parameter 'Delta Inch' < 0: negative travel direction
- Parameter 'Delta Inch' > 0: positive travel direction

If the parameter no. 13 'Spindle pitch' is programmed to zero, then there is an incremental travelling way. If the 'spindle pitch' is unequal zero, then the information of the 'Delta Inch' parameter refers to the travel distance in 1/100 mm.

Reaching the target position will be signalled in the system status word (bit 3).

- **Inching operation 2**

Inching operation 2 is started via STW.9 = '1'.

The drive moves as long as this bit = '1'.

The drive direction depends on STW.15:

STW.15 = '0' ⇒ positive travel direction

STW.15 = '1' ⇒ negative travel direction

The inching speed can be influenced via two parameters and will be calculated in the drive as shown in the following example:

v - Inch (parameter no 9) = 50 rpm (changeable only during standstill)
 Offset Inching 2 (parameter no. 30) = 47% (changeable during inching operation)

In this example, the resulting inching speed is:

Inching speed = v - inch * offset inching 2 = rpm * 47% = **24 rpm**

Results are always rounded up to integers.

The minimum speed is 1 rpm.

- **Touch button operation**

By opening the two Phillips screws on the front plate the touch buttons can be accessed.

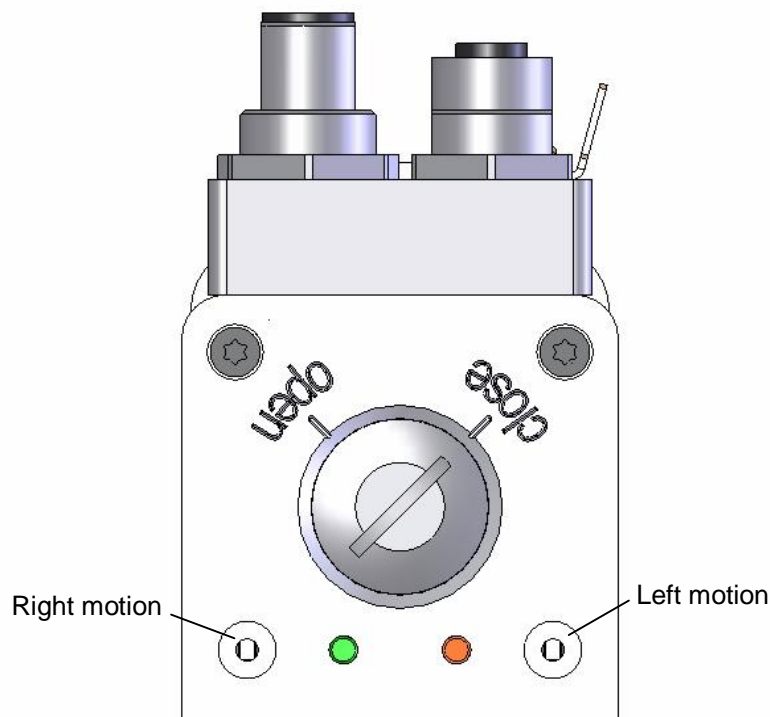

Touch button operation is only enabled if the Profibus State machine of the AG03 is *not* in the Data Exchange state!

The following conditions must be met for enabling the start of inching operations 1 and 2 or touch button operation via standard protocol:

- The AG03 must not be switched to fault (*system status word bit 8 = '0'*)
- No active travel job present (*system status word bit 14 = '0'*)
- Enable input activated (*system status word bit 10 = '0'*)



If the actual position is outside the programmed limiting values or a limit switch is active, then travelling from this position to the respective direction is possible by means of inching operations 1 or 2 or touch button operation!

2.2.2 Velocity mode

Parameter no 20 'operating mode' is programmed to velocity mode (see chapter 6: *Parameter description*).

In the velocity mode, the AG03 accelerates to the target velocity after release of the setpoint value (see chapter 7.5.6 *flowchart: velocity mode*) and maintains this velocity until the setpoint value is disabled or a new target velocity specified.

The speed is adjusted immediately to the new value when the rotational target speed is changed.

The arithmetical sign of the target value determines the travel direction in the velocity mode (see chapter 6: *Parameter description*).

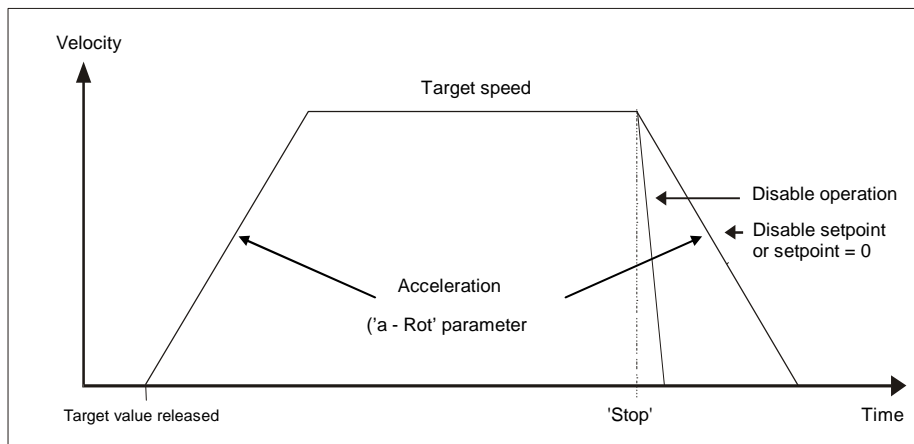

Fig. 5: Ramp velocity mode

The following conditions must be met for enabling start of velocity mode via the 'M' command of the standard protocol:

- The AG03 must not be switched to fault (*system status word bit 8 = '0'*)
- no active travel job present (*system status word bit 14 = '0'*)
- Enable input activated (*system status word bit 10 = '0'*)

If these conditions are met, this will be signalled in the system status word by bit 11 = '0'.



Limits 1 + 2 are deactivated in this operational mode!

2.3 Torque deactivation

A deactivation threshold is defined via the torque deactivation parameter (see chapter 6: *Parameter description* ⇒ *Parameter No. 29*). Percent values are entered.

Torque deactivation is disabled with a parameter value of 125%.

The drive will decelerate with maximum delay when the deactivation threshold is exceeded. Drive control will be maintained.



Active torque deactivation causes no error!

Active torque deactivation is returned via bit 7 = ,1' in parameter 1031_{dec} (general status register). This bit will be automatically reset when the current travel order is resumed.



This function is only available in the positioning mode!

2.4 Restore factory settings via DIP switches

Procedure for restoring factory settings via the 10-pin DIP switch:

1. Switch off supply voltage.
2. Set DIP switches 1 – 8 depending on the parameters to be reset:

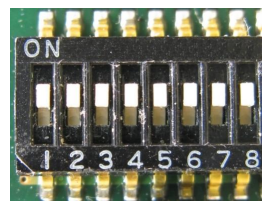
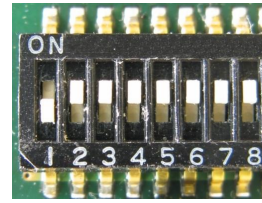
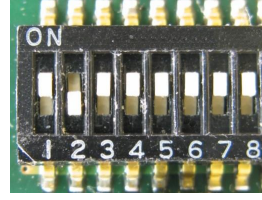
Reset all parameters (see chapter 6: Parameter description) to factory settings	
Reset only standard parameters (see chapter 6: Parameter description) to factory settings	
Reset only controller parameters (see chapter 6: Parameter description) to factory settings	

3. Turn on supply voltage. AG03 acknowledges with alternating blinking of the status LED and the bus LED.
4. Switch off supply voltage.
5. Set the original bus address via DIP switches 1 - 7.
6. DIP switch number 8 must be set to the OFF position.
7. After next switching on of supply voltage, the previously selected parameters will have been reset to the factory settings.

2.5 Enable input

The drive can only be started with enable input activated (i.e., high level is applied to the enable input). Removing enable results in immediate activating of the final stage.



If the drive is moving it will come to a stop unbraked!

2.6 Drive behavior in case of power failure



Power failure results in immediate loss torque. If the drive is moving at the time of power failure, then the drive will run out non-braked!

3 Calibration

Since the measuring system is an absolute system, calibration is necessary only once at start-up. During calibration, the position value of the AG03 is set to the programmed calibration value (see chapter 6: Parameter description \Rightarrow parameter no. 14).

The measuring system is calibrated via Profibus (see chapter 7.6: Parameterization via Profibus \Rightarrow parameter no. 970).



Calibration is only possible when no travel job is active!

4 External gear unit

If an external gear unit is used, a factor can be programmed via the parameter no. 11 'ü - Numerator' (numerator) and parameter no. 12 'ü - Denominator' (denominator), in order to include the gear ratio in position sensing (see also chapter 2.2.1.1).

Example (see fig. 7):

The AG03 is operated on a gear with transfer reduction of 5:1. For this purpose, the parameters 'ü-Numerator' and 'ü-Denominator' must be programmed as follows:

- Parameter 'ü - Numerator' : 5
- Parameter 'ü - Denominator' : 1

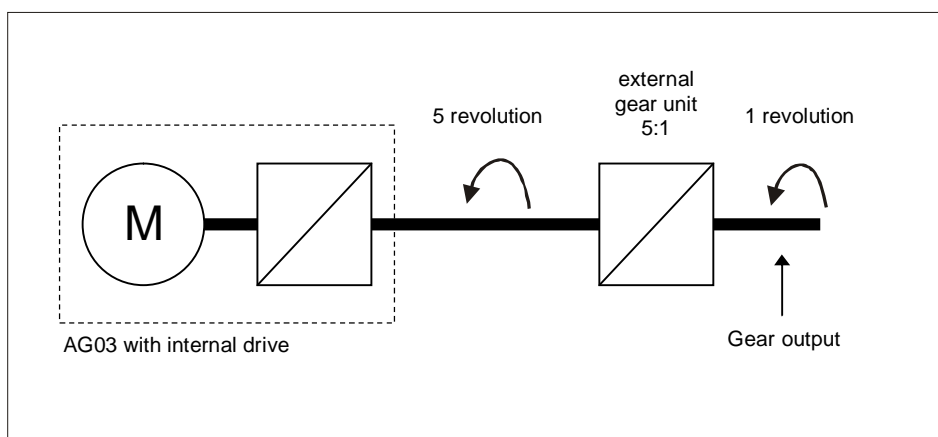

Fig. 7: External gear unit

Input of an odd gear reduction value is possible according to the following example:

Transfer reduction = 3.78

- Parameter 'ü - Numerator' : 378
- Parameter 'ü - Denominator' : 100

5 Warnings / Faults

The AG03 distinguishes between warnings and faults:

5.1 Warnings

Warnings do not influence the operation of the positioning drive. Warnings disappear after removing their causes.

Possible warnings:

- Battery voltage for absolute encoder is below limit \Rightarrow exchange battery within the next 6 months (see chapter 2.1: system status word \Rightarrow bit 12).
- Motor current beyond the permissible range (see chapter 2.1: System status word \Rightarrow bit 13).
 \Rightarrow if this condition lasts longer than 4 seconds, the AG03 will switch to fault.
- Lag error present (see chapter 2.1: System status word \Rightarrow bit 15) \Rightarrow AG03 cannot reach programmed speed because load is too high.

5.2 Faults

Faults induce an immediate stop of the positioning drive. The status-LED signalizes the fault status (see User information). Based on the blink code, the cause of the fault can be tracked down (see tab. 2: Error codes). Furthermore, an existing fault can be recognized via ZSW.3 = '1'. Faults must be acknowledged after clearing the faults (STW.7 = '1').

The error messages are entered in the error buffer in the order of their detection. The last 10 fault messages are displayed when the fault buffer is full.

The cause of an error can be tracked down with the help of the error codes (see table 2: Error codes).

The error buffer is stored in the EEPROM and can be deleted via Profibus Parameter 970_{dez.}

5.2.1 Error codes

The following table lists possible error causes:

Value error buffer	Blink code green Status-LED	Error description
A	blinking 1 time	supply voltage too low Error condition: Supply voltage < 18V + motor current > 200mA
B	blinking 2 times	blocked drive shaft Error condition: Revolutions per minute < rpm + contouring error
C	blinking 3 times	motor current too high Error condition: Motor current > 2,4A more than 4s
D	blinking 4 times	output stage temperature too high Error condition: Output stage temperature > 90°C
E	blinking 5 times	reserved
F	blinking 6 times	internal error
G	blinking 7 times	intermediate circuit voltage too high Error condition: Intermediate circuit voltage > 35V

Table 2: Error codes

6 Parameter description

This chapter describes the parameters of the AG03.

All parameters are stored in the **non-volatile** EEPROM, except for parameter no. 24 (target value) and parameter no. 30 (Offset inching 2).

* Controller parameters

** Standard parameters

Nr.	Name	Selection / value	Default	Description
1	Controller parameter P *	1 – 500	100	P gain of controller: valid for all operating modes (positioning mode, velocity mode, inching operation) <i>Profibus chapter 7.6: parameter no. 1000 dec</i>
2	Controller parameter I *	0 – 500	5	I gain of controller: valid for all operating modes (positioning mode, velocity mode, inching operation) <i>Profibus chapter 7.6: parameter no. 1001 dec</i>
3	Controller parameter D *	0 – 500	0	D gain of controller: valid for all operating modes (positioning mode, velocity mode, inching operation) <i>Profibus chapter 7.6: parameter no. 1002 dec</i>
4	a – Pos *	1 – 100	50	Acceleration in positioning mode: values in % (100% ⇒ 4rev/sec./sec.) <i>Profibus chapter 7.6: parameter no. 1003 dec</i>
5	v – Pos *	1 – 100 1 – 200	30	Maximum speed in positioning mode: values in revolutions/min gear ratio 48:1 ⇒ max. 100 rev/min gear ratio 24:1 ⇒ max. 200 rev/min <i>Profibus chapter 7.6: parameter no. 1004 dec</i>
6	a - Rot *	1 – 100	50	Acceleration in velocity mode: values in % (100% ⇒ 4 rev /sec./sec.) <i>Profibus chapter 7.6: parameter no. 1005 dec</i>
7				reserved
8	a - Inch *	1 – 100	50	Acceleration in inching operation 1 /2: values in % (100% ⇒ 4 rev /sec./sec.) <i>Profibus chapter 7.6: parameter no. 1007 dec</i>
9	v - Inch *	1 – 100 1 – 200	30	Maximum speed in inching operation 1 /2: values in revolutions/min gear ratio 48:1 ⇒ max. 100 rev/min gear ratio 24:1 ⇒ max. 200 rev/min <i>Profibus chapter 7.6: parameter no. 1008 dec</i>
10	Pos- Window **	0 - 1000	10	Positioning mode: positioning window If the actual position of the AG03 is within the programmed target value ± this window, this is signalled by setting bit 3 in the system status word of the AG03 (see chapter 2.1). Spindle pitch = 0: Information refers to increments Spindle pitch ≠ 0: Information refers to travelling distance in 1/100 mm Velocity mode: Velocity window If the actual velocity is within the target velocity ± this window, this is signalled by setting bit 3 in the system status word of the AG03 (see chapter 2.1). <i>Profibus chapter 7.6: parameter no. 1009 dec</i>
11	ü – Numerator**	1 – 10000	1	Numerator gear ratio: a gear ratio can be programmed here when a gear unit is used (see chapter 4: external gear unit). <i>Profibus chapter 7.6: parameter no. 1010 dec</i>

Nr.	Name	Selection / value	Default	Description
12	ü – Denominator**	1 – 10000	1	Denominator gear ratio: a gear ratio can be programmed here when a gear unit is used (see chapter 4: external gear unit). <i>Profibus chapter 7.6: parameter no. 1011 dec</i>
13	Spindle pitch **	0 – 1000	0	Spindle pitch: Spindle pitch = 0: Position value is output in increments (1,600 increments per revolution of the driving shaft of the AG03). Spindle pitch parameter ≠ 0: (when operating the AG03 on a spindle) Position value is no longer output as increments, but as travelling distance in 1/100 mm. Target position is entered now as 1/100 mm, too. Spindle pitch value in 1/100mm. e.g. spindle with a pitch of 2mm ⇒ spindle pitch parameter = 200. <i>Profibus chapter 7.6: parameter no. 1012 dec</i>
14	Calibration value **	-999999 to 999999	0	Calibration value: Writing a value in this parameter results in the take-over of this value as the absolute position for the AG03. Caution! Value must be within the range of the preprogrammed limiting values. <i>Profibus chapter 7.6: parameter no. 1018 dec</i>
15	Limit 1 **	-9999999 to 9999999	1000000	Positioning mode: limit 1 Spindle pitch = 0: Information refers to increments Spindle pitch = ≠0: Information refers to travelling distance in 1/100mm If the AG03 is beyond the range defined by limit 1 and limit 2 (travel range), travelling will only be possible in the direction of the travel range in inching mode. Caution! Limit monitoring is deactivated if 'limit 1' is equal 'limit 2'. Please note that there is a jump of the actual position if the resolution of the absolute encoder is exceeded! Velocity mode: no meaning <i>Profibus chapter 7.6: parameter no. 1016 dec</i>
16	Limit 2 **	-9999999 to 9999999	-1000000	Positioning mode: limit 2 Spindle pitch = 0: Information refers to increments Spindle pitch = ≠0: Information refers to travelling distance in 1/100 mm If the AG03 is beyond the range defined by limit 1 and limit 2 (travel range), travelling will only be possible in the direction of the travel range in inching mode. Caution! Limit monitoring is deactivated if 'limit 1' is equal 'limit 2'. Please note that there is a jump of the actual position if the resolution of the absolute encoder is exceeded! Velocity mode: no meaning <i>Profibus chapter 7.6: parameter no. 1017 dec</i>
17	Delta Inch **	-1000000 to 1000000	1600	Delta travelling distance with inching operation 1: indicates the relative travelling distance. positive value ⇒ positive travelling direction negative value ⇒ negative travelling direction Spindle pitch = 0: Information refers to increments Spindle pitch = ≠0: Information refers to travelling distance in 1/100 m <i>Profibus chapter 7.6: parameter no. 1019 dec</i>

Nr.	Name	Selection / value	Default	Description
18	Sense of rotation **	i , e	i	Counting direction of the measuring system: When the shaft rotates counter-clockwise (view on the clamping ring of the AG03). i sense of rotation: ⇒ positive counting direction e sense of rotation: ⇒ negative counting direction <i>Profibus chapter 7.6: parameter no. 1013 dec</i>
19	Pos Type **	direct loop + sloop -	direct	Positioning mode: Type of positioning <i>direct:</i> direct travelling from actual position to target value <i>loop +:</i> travelling to the target value occurs always in positive direction to compensate for spindle play <i>loop -:</i> travelling to the target value occurs always in negative direction to compensate for spindle play. Caution! Loop positioning in positioning mode only. Velocity mode: no meaning <i>Profibus chapter 7.6: parameter no. 1014 dec</i>
20	Operating mode **	positioning mode / speed mode	positioning mode	Positioning mode: <i>(see chapter 2.2.1: Positioning mode)</i> Velocity mode: <i>(see chapter 2.2.2: Velocity mode)</i> <i>Profibus chapter 7.6: parameter no. 930 dec</i>
21				reserved
22				reserved
23				reserved
24	Setpoint **	see column 'Description'	0	Positioning mode: indicates absolute target position. Spindle pitch = 0: Information refers to increments Spindle pitch = ≠0: Information refers to travelling distance in 1/100 m Value range: depends on the pre-programmed target values (<i>parameters 15/16</i>) Velocity mode: indicates the target velocity in rev./min. Value range: gear ratio 48:1 ⇒ max. ±100 rev/min gear ratio 24:1 ⇒ max. ±200 rev/min <i>Profibus chapter 7.4: Telegram setup (Data Exchange)</i> Attention! Target value will not be stored in the EEPROM
25	Stop mode Inching mode 2 **	0/1	0	Stop mode inching mode 2 / touch button mode The stop behaviour of inching mode 2 or touch button operation can be parameterized in different ways. Stop mode = 0 stop with maximum delay Stop mode = 1 stop with pre-programmed delay (<i>parameter no. 8</i>) <i>Profibus chapter 7.6: parameter no. 1021 dec</i>
26	Inpos mode **	0/1/2	0	Operating mode: positioning mode: The drive's behaviour upon reaching the positioning window can be determined by this parameter: Inpos mode = 0 position control to setpoint value Inpos mode = 1 position control OFF and short circuit of motor windings Inpos mode = 2 position control OFF and release of drive Velocity mode: no meaning <i>Profibus chapter 7.6: parameter no. 1022 dec</i>



Nr.	Name	Selection / value	Default	Description
27	Loop length**	0 - 10000	800	Operating mode: positioning mode: Indicates the loop length in increments Velocity mode: no meaning <i>Profibus chapter 7.6: parameter no. 1023 dec</i>
28				reserved
29	Torque deactivation **	20 - 125	125	Operating mode: positioning mode: This parameter determines the threshold of torque deactivation. Percent values are to be entered. Value 125: Torque deactivation disabled. Velocity mode: no meaning <i>Profibus chapter 7.6: parameter no. 1032 dec</i>
30	Offset inching 2 **	10 - 100	100	Inching operation 2 With this parameter, inching speed in inching operation 2 can be influenced. Indication is percentage of parameter no. 9. Caution! This parameter is no stored in the EEPROM. <i>Profibus chapter 7.6: parameter no. 1035 dec</i>

Table 6: Parameter description

7 Communication via Profibus – DP

7.1 General remarks

This chapter describes the activation and parameterization of the AG03 via Profibus interface. For the pin assignment of the Profibus interface please refer to the user information.

7.2 Interface

Profibus – DP is an international standardized, open fieldbus standard and is defined in the standards:

- European Fieldbus Standard EN50170
- DIN 19245 parts 1 and 3

The fieldbus is used for cyclic data exchange between a master and the subordinate slaves.

- Masters determine data traffic on the bus and are called 'active stations'.
- Slaves can only acknowledge received messages or transfer messages to the master upon inquiry. Slaves are called 'passive stations'.

The AG03 is operated on the Profibus-DP as a slave (passive bus station) and can, therefore, acknowledge messages or send data only upon inquiry from the master. The AG03 automatically recognizes the baud rate of the Profibus-DP. The master uniformly sets the baud rate for all devices connected to the Profibus.

The AG03 supports the following baud rates:

- 9,6 kBd, 19,2 kBd, 93,75 kBd, 187,5 kBd, 500 kBd, 1,5 MBd, 3 MBd, 6 MBd, 12 MBd

Line length:

Baud rate in kbit/s	9,6	19,2	93,75	187,5	500	1500	3000	6000	12000
Line length in m	1200	1200	1200	1000	400	200	100	100	100

Table 7: Line length

Termination of the Profibus-DP line:

If the ASG03 is at the end of the bus, the Profibus connection must be terminated using a defined bus terminator. In the AG03 this is accomplished via an internal resistor combination that can be connected via DIP switches SW9 + SW10 (see chapter 7.9: Profibus bus terminator).

7.3 Data exchange

The flow charts, control functions and status messages as well as the type of cyclic data traffic between master and AG03 (slave) are based on the processes and data structures defined in the document

Profibus profile for adjustable speed drives, PROFIDRIVE version 2

(September 1997 issue, PNO order no. 3.071).

7.4 Telegram setup (Data Exchange)

During operation (Data exchange \Rightarrow orange Profibus-LED is lighting, see *User information*), 7 data words are cyclically exchanged between a master and the AG03.

The structure of these data words for cyclic data traffic is called "Parameter Process data Object" (PPO) in the Profibus profile "Adjustable-speed Drives" PROFIDRIVE version 2.

7.4.1 Parameter Process Data Object

Such a Parameter Process data Object (PPO) consists of two parts:

- Parameter data range (see chapter 7.4.2: *Parameter identification value*)
Any parameter in the AG03 can be monitored or changed by means of the PKW telegram portion (parameter identification value).
- Process data range (see chapter 7.4.3: *Process data*)
Control words and target values (master \Rightarrow slave) or status words and actual values (slave \Rightarrow master), respectively, can be transferred with the process data.

Definition of the Parameter Process data Object

A special PPO type with fixed data length (7 data words) has been defined for the AG03:

PKW (4 words)				PZD (3 words)		
				PZD1	PZD2	PZD3
PKE	IND	PWE		STW ZSW	HSW HIW	HSW (master \Rightarrow slave) HIW (slave \Rightarrow master)
MSW						LSW
word 1	word 2	word 3	word 4	word 5	word 6	word 7

Fig. 8: PPO setup



PKW:	Parameter identification value
PKE:	Parameter identification
IND:	Index
PWE:	Parameter value
PZD1...3:	Process data 1 ...3
STW:	Control word
ZSW:	Status word:
HSW:	Main target value
HIW:	Main actual value
LSW:	lowest-value data word
MSW:	highest-value data word

7.4.2 Parameter identification value (PKW)

Parameter processing in cyclic data traffic is executed via the PKW portion of the PPO. Here the master formulates a job and sends it to the slave. The master repeats the job until the slave has processed the job and given its reply. The slave makes available the reply until the master formulates a new job. Only one job can be processed at the same time.

7.4.2.1 Parameter identification (PKE)

The parameter identification PKE consists of a data word, in which the type of the job/reply and the associated parameter number has been coded.

The parameter identification is made up as follows:

PKE (Parameter identification)															
15	14	13	12	11	10	9	8	7	6	5	4	3	2	1	0
AK				SPM	Parameter number (PNU)										

Fig. 9: PKE setup

AK: Job or reply identification, respectively

SPM: Toggle bit for spontaneous message ⇒ function not implemented (status does not matter)

PNU: Parameter number

Job/reply processing is defined in such a way that the content of the job identification field determines which fields of the PKW interface (index and/or parameter value (PWE)) must be interpreted as well.

Job identification (master ⇒ slave)

Job identification	Function	Reply identification (possible answers from slave)	
		positive	negative
0	No job	0	7 or 8
1	Request parameter value	1 or 2	
2	Change parameter value (word)	1	
3	Change parameter value (double word)	2	
4	Request description element	3	
5	Change description element	3	
6	Request parameter value (array)	4 or 5	
7	Change parameter value (array word)	4	
8	Change parameter value (double word)	5	
9	Request number of array elements	6	

Table 8: Job identification

The right column, Reply identification, refers to the replies from the slave (see table 9: Reply identification). In the normal case there is a positive reply, in case of a fault the reply is negative.

Reply identification (slave ⇒ master)

Reply identification	Function
0	No reply
1	Parameter value transferred (word)
2	Parameter value transferred (double word)
3	Description element transferred
4	Parameter value transferred (array word)
5	Parameter value transferred (array double word)
6	Number of array elements transferred
7	Job cannot be executed
8	No authorization for PKW interface

Table 9: Reply identification

Parameter number (master ⇒ slave, slave ⇒ master)

This field contains the number of the parameter whose data is transferred in the Parameter Value (PWE) field.

7.4.2.2 Sub-index (IND)

This field contains the array sub-index in the case of jobs and replies that refer to array elements.

7.4.2.3 Parameter value (PWE)

This field contains the numerical value of the parameter present in the Parameter Number (PNU) (see chapter 7.6: Parameterization ⇒ table 15).

The PWE transfer of word sizes is realized with word 4 of the PPO, transfer of double word sizes is realized with word 3 and word 4 of the PPO (see fig. 8: PPO setup).

In the case of non-executable jobs the slave replies with an error number as described in the table below:

No.	Meaning
0	illegal parameter number
1	parameter value cannot be changed
2	upper or lower limit exceeded
3	faulty sub-index
4	no array
5	wrong data type
6	no setting permitted (only resettable)
7	description element cannot be changed
8	PPO Write required in IR not available
9	description data not available
10	wrong access group
11	no authorization
12	wrong password
13	text in cyclic traffic not readable
14	name in cyclic traffic not readable
15	no text array available
16	PPO is missing
17	job cannot be executed due to operating state
18	other error
19	date in cyclic traffic not readable

Table 10: Error numbers with reply

7.4.3 Process data (PZD)

In the process data portion all information is transferred, which is exchanged in normal cyclic travelling operation, i.e., control commands, target values from master to drive or status word, respectively, actual values from drive to master. Due to the two operating modes of the AG03 (positioning mode and velocity mode) there are different meanings for individual parameters. The process data portion is set up as follows:

Data transfer (master \Rightarrow slave)

PZD		
STW	target value	
	high word	low word

Fig. 10: Process data master \Rightarrow slave

Control word (STW)

For a description of the control word in positioning mode refer to chapter 7.5.1

For a description of the control word in velocity mode refer to chapter 7.5.4

Target value:

The target value consists of 4 bytes and has a different meaning depending on the operating mode:

- Positioning mode
Target value contains the target position applicable to the next travelling job.
The value must be in the range of the pre-programmed limiting values
(see chapter 7.6: Parameterization, parameter nos 1016/1017)!
- Velocity mode
Target value contains the target velocity value in rev./min.

Data transfer slave \Rightarrow master

PZD		
ZSW	actual value	
	high word	low word

Fig. 11: Process data slave \Rightarrow master

Status word ZSW:

Description: Positioning mode, see chapter 7.5.2

Velocity mode, see chapter 7.5.5

Actual value:

The actual value consists of 4 bytes and has a different meaning depending on the operating mode:

- Positioning mode
The actual value contains the actual position value
- Velocity mode
The actual value contains the actual velocity

7.5 Functional description of the control units

The control and status words are represented as follows:

high byte								low byte							
bit number															
15	14	13	12	11	10	9	8	7	6	5	4	3	2	1	0
0	0	1	0	1	0	0	1	0	1	0	0	1	0	0	0
2				9				4				8			

Fig. 12: Representation of control and status words

Example (grey background):

binary: \Rightarrow 0010 1001 0100 1000

hex: \Rightarrow 2 9 4 8

7.5.1 Control word in positioning mode (master ⇒ slave)

Bit	Value	Designation acc. to PROFIDRIVE	AG03 description
0	1	ON	OFF 1: not active (operational condition)
	0	OFF 1	OFF 1: cancellation of positioning job (motor enabled, ready-to-run state) / release from turn-on interlock
1	1	Operating condition	OFF 2: not active
	0	OFF 2	OFF 2: cancellation of positioning job (motor enabled, ready-to-run state)
2	1	Operating condition	Not implemented must be statically set to '0'
	0	OFF 3	
3	1	Operation enabled	Enable operation
	0	Disable operation	Operation disabled Motor decelerates with maximum deceleration and assumes ready-to-run state. Motor remains in control state.
4	1	Operating condition for positioning	Must continuously be pending for travel job. Activation of travelling job via edge on bit 6
	0	Stop	Drive decelerates with maximum deceleration. Current positioning job is discarded. Motor remains in control state.
5	1	Operating condition for positioning	Must continuously be pending for executing a travel job.
	0	Intermediate stop	Drive decelerates from an active travel job with pre-programmed deceleration to n=0 and comes to a standstill with a stop torque. The travel job is not discarded. The travel job is continued after changing to bit 5=1.
6	Edge 0/1 1/0	Activate travel job	Each edge enables a new travel job with the current target value.
7	1	Acknowledge	Acknowledge fault. Turning on of the AG03 will be disabled.
	0	no meaning	-
8	1	Inching 1 On	Condition: Operation is enabled and no active positioning process Drive travels once by delta-Inch target value.
	0	Inching 1 Off	Inching 1 off
9	1	Inching 2 On	Condition: Operation is enabled and no active positioning process. Drive travels until Inching 2 is OFF. Direction depends on bit 15.
	0	Inching 2 Off	Inching 2 off
10 - 14		is not supported	-
15	1	AG03-specific	negative travel direction with inching operation 2
	0	AG03-specific	positive travel direction with inching operation 2

Table 11: Control word: Positioning mode

7.5.2 Status word: Positioning mode (slave ⇒ master)

Bit	Value	Designation acc. to PROFIDRIVE	AG03 description
0	1	Ready to turn on	Supply voltage for motor and electronics unit applied.
	0	Not ready to turn on	
1	1	Ready	identical with bit 0.
	0	Not ready	
2	1	Operation enabled	Positioning operation enabled.
	0	Operation disabled	Positioning operation disabled.
3	1	Error	Drive faulty and, therefore, out of operation; turn-on disabled after acknowledgement and successful fault correction. Error code in fault buffer.
	0	Faultless	
4	1	No OFF 2	No pending OFF 2 command.
	0	OFF 2	OFF 2 command pending.
5	1	No OFF 3	Not implemented
	0	OFF 3	Statically on '1'
6	1	Turn-on disabled	Restart only via "OFF 1" with subsequent "On".
	0	Turn-on not disabled	
7	1	Warning	Drive still in operation, no acknowledgement required (<i>Warnings see chapter 5.1</i>).
	0	No warning	No pending warning or warning has disappeared.
8	1	No lag error	No lag error present (<i>see chapter 2.1: system status word bit 15</i>)
	0	Lag error	
9	1	Guide required	Not supported (statically on '1').
	0	On-site operation	
10	1	Target position reached	The absolute position value is at the end of a travel job in the positioning window.
	0	Outside target position	
11	1	Reference point set	Function not implemented because it is an absolute system (statically on '1').
	0	No reference point set	
12	Edge 0/1 1/0	Acknowledgement of target value	'Edge' acknowledges that a new positioning job was taken over.
13	1	Drive stands still	Signals standstill in case of intermediate stop and stop.
	0	Drive travels	Travel job is executed
14	1	Limiting value for position exceeded	Position limiting value exceeded in positive or negative direction. Travelling possible only via inching operation.
	0	Within position limit	Position value is within pre-programmed limiting values.
15	1	ready-to-travel	AG03 is ready-to-travel if operation has been enabled (ZSW.2 = '1') <ul style="list-style-type: none"> • Enable input activated • no limits have been exceeded • no fault is active • no current positioning is active
	0	not ready-to-travel	AG03 is not ready-to-travel

Table 12: Status word: Positioning mode



7.5.3 Flow chart: Operating mode: Positioning mode

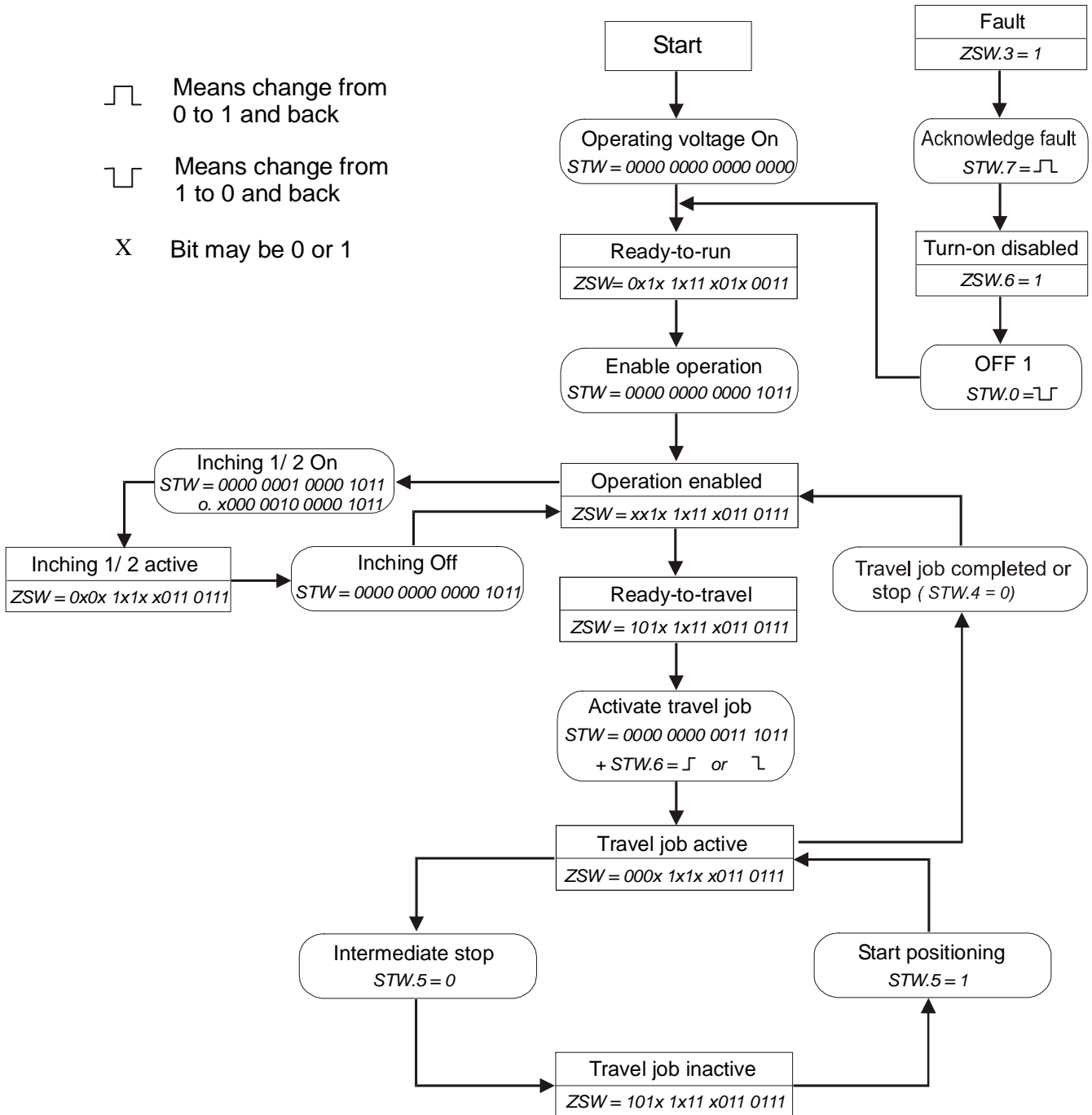

Fig. 13: Flow chart: Positioning mod

7.5.4 Control word: Velocity mode (master ⇒ slave)

Bit	Value	Designation acc. to PROFIDRIVE	AG03 description
0	1	ON	OFF 1: not active (operational condition)
	0	OFF 1	OFF 1: Cancellation of travel job (motor enabled, ready-to-run state) / Release from turn-on interlock
1	1	Operating condition	OFF 2: not active
	0	OFF 2	OFF 2: Cancellation of positioning job (motor enabled, ready-to-run state)
2	1	Operating condition	Not implemented must be statically set to '0'
	0	OFF 3	
3	1	Enable operation	Enable operation
	0	Disable operation	Disable operation Motor decelerates with maximum deceleration and assumes ready-to-run state. Motor remains in control state.
4	1	Operating condition	Not implemented
	0	Disable starting encoder	
5	1	Enable starting encoder	Not implemented
	0	Stop starting encoder	
6	1	Enable target value	Target value is enabled, drive rotates with preset velocity.
	0	Disable target value	Drive runs out with pre-programmed deceleration Motor remains in control state.
7	1	Acknowledge	Acknowledge fault. Turning on of the AG03 will be disabled.
	0	no meaning	
8 - 15		is not supported	

Table 13: Control word: Velocity mode

7.5.5 Status word: Velocity mode (slave ⇒ master)

Bit	Value	Designation acc. to PROFIDRIVE	AG03 description
0	1	Ready to turn on	Supply voltage for motor and electronics unit applied.
	0	Not ready to turn on	
1	1	Ready	identical with bit 0.
	0	Not ready	
2	1	Operation enabled	Velocity mode enabled.
	0	Operation disabled	Velocity mode disabled.
3	1	Error	Drive faulty and, therefore, out of operation; turn-on disabled after acknowledgement and successful error correction. Error code in fault buffer.
	0	Faultless	
4	1	no OFF 2	No pending OFF 2 command.
	0	OFF 2	OFF 2 command pending.
5	1	no OFF 3	Not implemented statically on '1'
	0	OFF 3	
6	1	Turn-on disabled	Restart only via "OFF 1" with subsequent "On".
	0	Turn-on not disabled	
7	1	Warning	Drive still in operation, no acknowledgement required (<i>Warnings see chapter 5.1</i>).
	0	No warning	Drive still in operation, no acknowledgement required.
8	1	Monitoring of required/actual values within tolerance range	Actual velocity is within the velocity window of the target velocity.
	0	Monitoring of required/actual values outside tolerance range	
9	1	Guide required	Not supported (statically on '1')
	0	On-site operation	
10	1	f or n reached	Not supported (statically on '1')
	0	Below f or n	
11 and 12		Device-specific	Not supported (statically on '1')
13	1	Drive stands still	Signals standstill at stop.
	0	drive travels	Drive shaft rotates.
14		Device-specific	Not supported (statically on '1')
15	1	ready-to-travel	AG03 is ready-to-travel if <ul style="list-style-type: none"> • operation has been enabled (ZWS.2 = '1') • no fault is active • Enable input activated • velocity mode is not active (STW.6 = '0')
	0	not ready-to-travel	AG03 is not ready-to-travel

Table 14: Status word: Velocity mode



7.5.6 Flow chart: Operating mode: Velocity mode

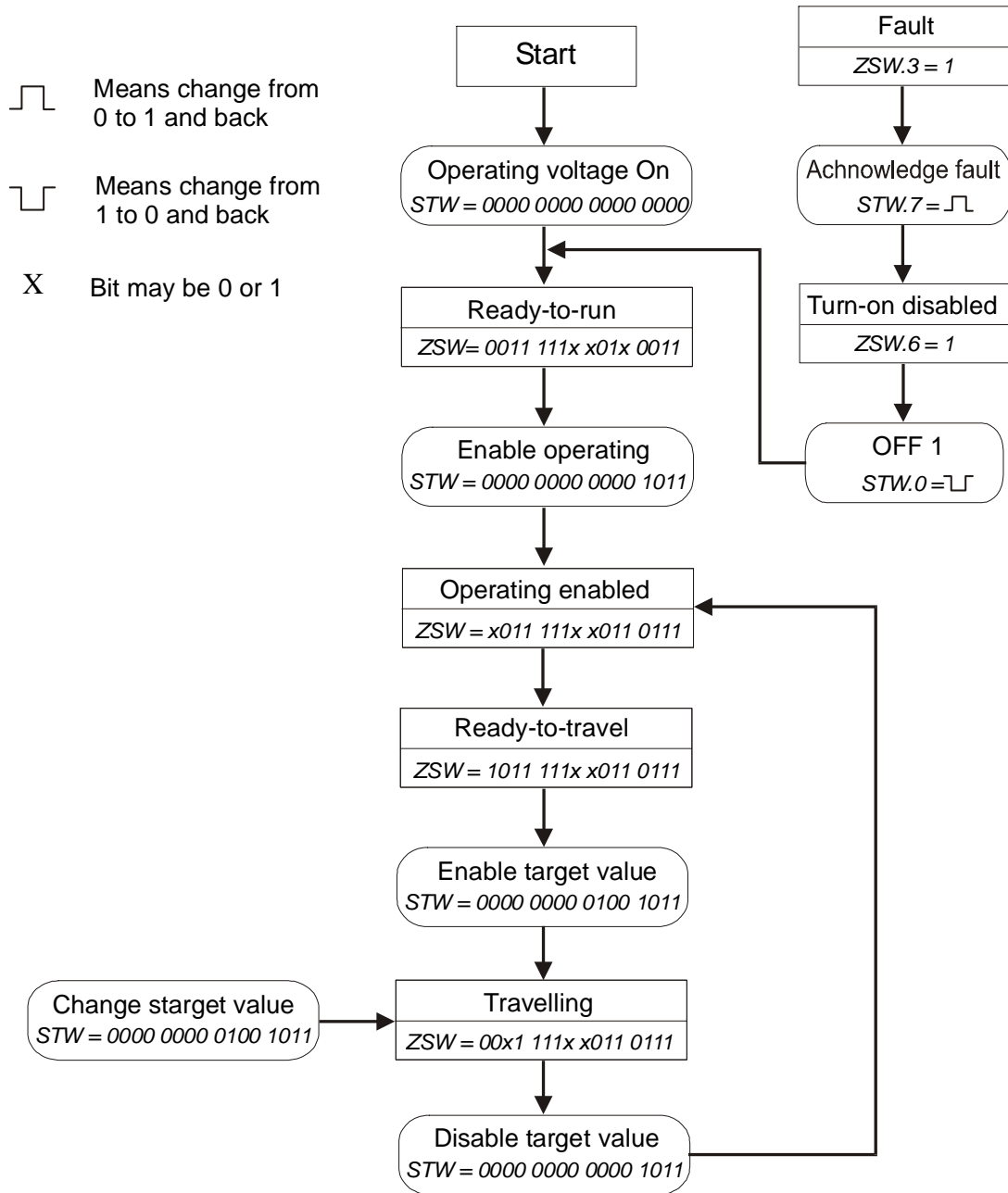

Fig. 14: Flow chart: Velocity mode

7.6 Parameterization via Profibus

A parameter number is assigned to every parameter of the AG03 that serves to read out or change the parameters by means of the PKW mechanism (see chapter 7.4.2: PKW). Changes of the parameters are stored in the non-volatile EEPROM.

If the Profibus master sends illegal values to the AG03, this results in an error message (see Table 10: Error numbers with reply).

For the meaning of the individual parameters please refer to chapter 6: 'Parameter description'.

Parameter No.	Name	Access	Format	Description
918 _{dec} 396 _{hex}	Profibus Address	read	word	Under this parameter number the preset Profibus address can be read out.
930 _{dec} 3A2 _{hex}	Operating mode	read / write	word	PWE = 1: Velocity mode PWE = 2: Positioning mode (see chapter 6: ⇒ parameter no. 21)
945 _{dec} 3B1 _{hex}	Fault buffer	read	Array [10] word	This parameter is defined as an array with 10 entries. In this array, occurring faults are entered with their fault codes. This fault code can be read out via parameter number and indication of the sub-index (0 to 9). The fault codes are stored in the EEPROM The fault codes are output as ASCII characters from 'A' to 'E'. The fault buffer can be deleted via parameter no. 970 _{dez} . <u>Example:</u> PWE = 41: corresponds to ASCII 'A' For the meaning of the individual characters please refer to chapter 5.2: ⇒ table 2: error codes.
952 _{dec} 3B8 _{hex}	Number of faults	read	word	Here the number of faults occurring can be read out. The number of faults is stored in the EEPROM.
961 _{dec} 3C1 _{hex}	Hardware version	read	word	The gear reduction of the AG03 can be read out. PWE = 2: gear reduction 24:1 PWE = 3: gear reduction 48:1
965 _{dec} 3C5 _{hex}	Software-version	read	word	The software version of the AG03 can be read out via this parameter, e.g., 0101 _{hex} means version 1.01.
970 _{dec} 3CA _{hex}	Load parameter data record	write	word	PWE = 1: Set all parameters to default values (bus address is not changed). PWE = 2: Set standard parameters to default value (see chapter 6: Parameter description). Controller parameters are maintained. PWE = 3: Set controller parameters to factory settings. Standard parameters are maintained. PWE = 4: Delete fault counter and fault buffer. PWE = 5: calibrate the AG03 PWE is set to zero after successful execution (for default values refer to chapter 6: Parameter description)
1000 _{dec} 3E8 _{hex}	Controller parameter P	read / write	word	Value range: 1 – 500 (meaning: see chapter 6: ⇒ parameter no. 1)

Parameter No.	Name	Access	Format	Description
1001 _{dec} 3E9 _{hex}	Controller parameter I	read / write	word	Value range: 1 – 500 (meaning: see chapter 6: ⇒ parameter no. 1)
1002 _{dec} 3EA _{hex}	Controller parameter D	read / write	word	Value range: 0 – 500 (meaning: see chapter 6: ⇒ parameter no. 3)
1003 _{dec} 3EB _{hex}	a – Pos	read / write	word	Value range: 0 – 100 (meaning: see chapter 6: ⇒ parameter no. 4)
1004 _{dec} 3EC _{hex}	v – Pos	read / write	word	Value range: gear ratio 24:1 ⇒ 1 – 200 gear ratio 48:1 ⇒ 1 – 100 (meaning: see chapter 6: ⇒ parameter no. 5)
1005 _{dec} 3ED _{hex}	a – Rot	read / write	word	Value range: 0 – 100 (meaning: see chapter 6: ⇒ parameter no. 6)
1006 _{dec} 3EE _{hex}				reserved
1007 _{dec} 3EF _{hex}	a – Inch	read / write	word	Value range: 0 – 100 (meaning: see chapter 6: ⇒ parameter no. 8)
1008 _{dec} 3F0 _{hex}	v – Inch	read / write	word	Value range: gear ratio 24:1 ⇒ 1 – 200 gear ratio 48:1 ⇒ 1 – 100 (meaning: see chapter 6: ⇒ parameter no. 9)
1009 _{dec} 3F1 _{hex}	Pos- Window	read / write	word	Value range: 0 – 1000 (meaning: see chapter 6: ⇒ parameter no. 10)
1010 _{dec} 3F2 _{hex}	ü- Numerator	read / write	word	Value range: 1 – 10000 (meaning: see chapter 6: ⇒ parameter no. 11)
1011 _{dec} 3F3 _{hex}	ü – Denominator	read / write	word	Value range: 1- 10000 (meaning: see chapter 6: ⇒ parameter no. 12)
1012 _{dec} 3F4 _{hex}	Spindle pitch	read / write	word	Value range: 0 – 1000 (meaning: see chapter 6: ⇒ parameter no. 13)
1013 _{dec} 3F5 _{hex}	Sense of rotation	read / write	word	PWE = 0: i sense of rotation PWE = 1: e sense of rotation (meaning: see chapter 6: ⇒ parameter no. 18)
1014 _{dec} 3F6 _{hex}	Pos- type	read / write	word	PWE = 0: direct PWE = 1: loop + PWE = 2: loop – (meaning: see chapter 6: ⇒ parameter no. 19)
1015 _{dec} 3F7 _{hex}				reserved
1016 _{dec} 3F8 _{hex}	Limit 1	read / write	Double word	Value range: - 9999999 ... 9999999 (meaning: see chapter 6: ⇒ parameter no. 15)
1017 _{dec} 3F9 _{hex}	Limit 2	read / write	Double word	Value range: - 9999999 ... 9999999 (meaning: see chapter 6: ⇒ parameter no. 16)
1018 _{dec} 3FA _{hex}	Calibration value	read / write	Double word	Value range: - 999999 ... 999999 (for the meaning refer to see chapter 6: ⇒ parameter no. 14 and chapter 3: Calibration)
1019 _{dec} 3FB _{hex}	Delta Inch	read / write	Double word	Value range: - 1000000 ... 1000000 (meaning: see chapter 6: ⇒ parameter no. 17)
1020 _{dec} 3FC _{hex}	System status word	read	word	System status word of the AG03 for the meaning of the individual bits refer to chapter 2.1 'System status word'
1021 _{dec} 3FD _{hex}	Stop mode Inch2	read / write	word	PWE = 0: Inch2 - stop with maximum delay PWE = 1: Inch2 - stop with pre-programmed delay (meaning: see chapter 6: ⇒ parameter no. 25)

Parameter No.	Name	Access	Format	Description
1022 _{dec} 3FE _{hex}	Inpos mode	read / write	word	PWE = 0: Position control PWE = 1: short circuit of motor windings PWE = 2: motor released (meaning: see chapter 6: ⇒ parameter no. 26)
1023 _{dec} 3FF _{hex}	Loop length	read / write	word	Value range: 0...10000 (meaning: see chapter 6: ⇒ parameter no. 27)
1031 _{dec} 407 _{hex}	general status register	read	word	represents the status of the enable input and of torque deactivation. Bit 4: enable entry Bit 7: torquedeactivation Bit 0 - 3; 5 - 6; 8 - 15: not used Bit x = '1' active Bit x = '0' inactive
1032 _{dec} 408 _{hex}	Torque deactivation	read / write	word	Value range 20 – 125 (meaning: see chapter 6: ⇒ parameter no. 29)
1033 _{dec} 409 _{hex}	Serial number	read	Double word	Reading the serial number 1234567 _{dec} = serial number 1234567
1034 _{dec} 40A _{hex}	date of production	read	Double word	Read out date of production Format description (example): 15 07 20 09 _{hex} = 15.07.2009 = DDMMJJJJ
1035 _{dec} 40B _{hex}	Offset inching 2	read / write	word	Value range 10 - 100 (meaning: see chapter 6: ⇒ parameter no. 30)
1036 _{dec} 40C _{hex}	Position value	read	Double word	Read out position value

Table 15: Parameter description

7.6.1 Example: read parameter

The parameter Calibration value is to be read out:

Determination of parameter identification (PKE), consisting of AK, SPM, PNU:

1. Determination of job identification (AK)

Job identification = request parameter value = 1 (see table 8): Job identification

2. Determination of parameter number:

Parameter number 'calibration value' = 1018 = 3FA_h (see table 15).

3. SPM = 0;

⇒ **PKE = 13FA_h**

Parameter identification for the example 'Read parameter'

PKE (Parameter identification)																
Bit	15	14	13	12	11	10	9	8	7	6	5	4	3	2	1	0
Designation	AK				SPM	Parameter number (PNU)										
Binary value	0	0	0	1	0	0	1	1	1	1	1	1	1	0	1	0
Hex value	1				3			F				A				

Determination of the parameter identification value (PKW):

1. Determination of parameter identification (see above). PKE = 0x13FA

2. Determination of the index: Index (IND) = 0;

3. Parameter value (PWE) = 0

Telegram from master \Rightarrow slave:

PKW (4 words)			
PKE	IND	PWE	
word 1	word 2	word 3	word 4
0x13FA	0x0000	0x0000	0x0000

Telegram from slave \Rightarrow master with correct execution:

PKW (4 words)			
PKE	IND	PWE	
word 1	word 2	word 3	word 4
0x23FA	0x0000	0x0000	0x2710

PKE = 23FA_h

Reply identification = 2 = transfer parameter value (double word) (see table 9: Reply identification)

PWE = 2710_h = 10000

The current calibration value is 10000.

7.6.2 Example: Write parameter

The parameter 'limit 1' is to be set to 250000:

Determination of parameter identification (PKE), consisting of AK, SPM, PNU:

1. Determination of job identification (AK)

Job identification = change parameter value double word = 3 = 3_h
(see table 8): Job identification

2. Determination of parameter number:

parameter number 'limit 1' = 1016_{dez} = 3F8_h (see table 15).

3. SPM = 0;

\Rightarrow **PKE = 33F8_h**

Parameter identification for the example 'Write parameter'

PKE (Parameter identification)																
Bit	15	14	13	12	11	10	9	8	7	6	5	4	3	2	1	0
Designation	AK				SPM	Parameter number (PNU)										
Binary value	0	0	1	1	0	0	1	1	1	1	1	1	1	0	0	0
hex value	3				3			F				8				

Determination of the parameter identification value (PKW)

1. Determination of parameter *identification* (see above).

PKE = 0x33F8

2. Determination of the index:

Index (IND) = 0;

3. Determination of the parameter value (PWE)

Parameter value (PWE) = 250000 = 3D090_h

Telegram from master ⇒ slave:

PKW (4 words)			
PKE	IND	PWE	
word 1	word 2	word 3	word 4
0x33F8	0x0000	0x0003	0xD090

Telegram from slave ⇒ master with correct execution:

PKW (4 words)			
PKE	IND	PWE	
word 1	word 2	word 3	word 4
0x23F8	0x0000	0x0003	0xD090

PKE = 23F8_h

Reply identification = 2 = transfer parameter value (double word) (see table 9: Reply identification).

7.7 Diagnosis

Standard diagnosis for Profibus DP is supported.

Profibus diagnosis consists of 6 bytes with the following contents:

Byte	Bit	Description
Byte 1	0	Diag. station does not exist (set by master)
	1	Diag.station not ready Slave not ready for data exchange
	2	Diag.cfg_Fault Inconsistent configuration data
	3	Diag.ext_diag Slave has external diagnosis data
	4	Diag.not supported Requested function not supported by slave
	5	Diag.invalid slave response (fixes slave to 0)
	6	Diag.prm_fault wrong parameterization (ident number, etc.)
Byte 2	7	Diag.master_lock (set by master) Slave has been parameterized by other master
	0	Diag.prm_req Slave must be re-parameterized
	1	Diag.Stat_diag static diagnosis (byte diag- bits)
	2	fixed to '1'
	3	Diag.WD_ON Response monitoring active
	4	Diag.freeze_mode freeze command received
	5	Sync_mode sync command received
	6	reserved
7	Diag.deactivated (set by master)	
Byte 3	0	reserved
	1	reserved
	2	reserved
	3	reserved
	4	reserved
	5	reserved
	6	reserved
7	Diag.ext_overflow	

Byte	Bit	Description
Byte 4		Diag.master_add Master address after parameterization (FF without parameterization)
Byte 5		Ident number high byte
Byte 6		Ident number low byte

Table 16: Diagnosis bytes

Stat_diag:

The slave cannot provide valid data due to a condition in the application. As a result, the master requests only diagnosis data until this bit will be reset. The firmware does not support this bit (permanently on 0)

Ext_diag:

If this bit is set, then a diagnosis entry must be present in the user-specific diagnosis area. This bit is always 0 in the AG03, since no user-specific diagnosis data is supported.

Ext_diag_overflow:

This bit is set if more diagnosis data have been provided than would fit the diagnosis data available. This bit is permanently on 0.

7.8 Profibus address setup

The Profibus subscriber addresses can only be set via DIP switches.

After removing the closure screwed on the cover of the housing, the 10-pin DIP switch will be visible.

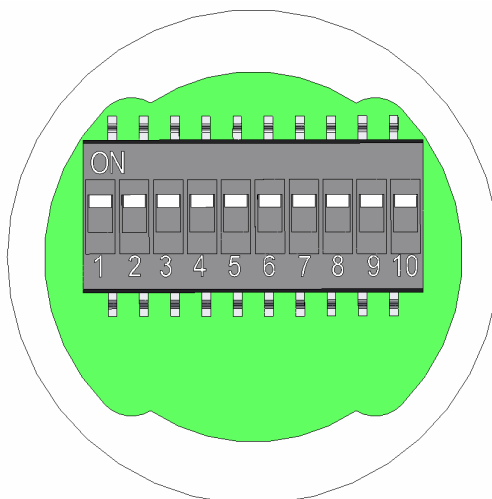

The slave address is entered via switches 1 – 7 in binary format. The setting of address 127 is internally set into address 126.

This is illustrated in the following table:

SW1 [2 ⁰]	SW2 [2 ¹]	SW3 [2 ²]	SW4 [2 ³]	SW5 [2 ⁴]	SW6 [2 ⁵]	SW7 [2 ⁶]	set slave address
OFF	OFF	OFF	OFF	OFF	OFF	OFF	0
ON	OFF	OFF	OFF	OFF	OFF	OFF	1
OFF	ON	OFF	OFF	OFF	OFF	OFF	2
ON	ON	OFF	OFF	OFF	OFF	OFF	3
:	:	:	:	:	:	:	:
OFF	OFF	ON	ON	ON	ON	ON	124
ON	OFF	ON	ON	ON	ON	ON	125
OFF	ON	ON	ON	ON	ON	ON	126
ON	ON	ON	ON	ON	ON	ON	126!



The DIP switch settings are only read when the supply voltage is switched on. Changing the slave address during operation has no effect.

7.9 Diagnosis LEDs

Various operational states are signalled via the diagnosis LEDs.

	State	Meaning
Status LED (green)	blinking	Drive out of order, meaning: see chapter 5.2.1
	ON	Enable applied
	OFF	No enable or no power supply
BUS LED (orange)	ON	Drive is in the data exchange mode
	OFF	Drive is not in the data exchange mode

7.10 Profibus bus terminator

The internal bus terminator can be activated via DIP switches 9 + 10:

SW9	SW10	Bus terminator
OFF	OFF	deactivated
ON	ON	active



It should be noted that both DIP switches are always required for correct function of bus termination.

7.11 Device data base and configuration

For the AG03 a device database file (GSD) named SIKO0AC5.GSD has been created. This file can be included in the device library by means of the configuration tool used, e.g., 'COM PROFIBUS' of the Siemens company (*for the procedure to be applied please refer to the documentation of the configuration tool*).